

# DESO

## ENGINEERING

Deso Engineering  
Slade Way  
Roughmoor Industrial Estate  
Williton  
Somerset  
TA4 4TB

Telephone - 01984 632026  
Fax - 01984 634267  
enquiries@desoengineering.co.uk

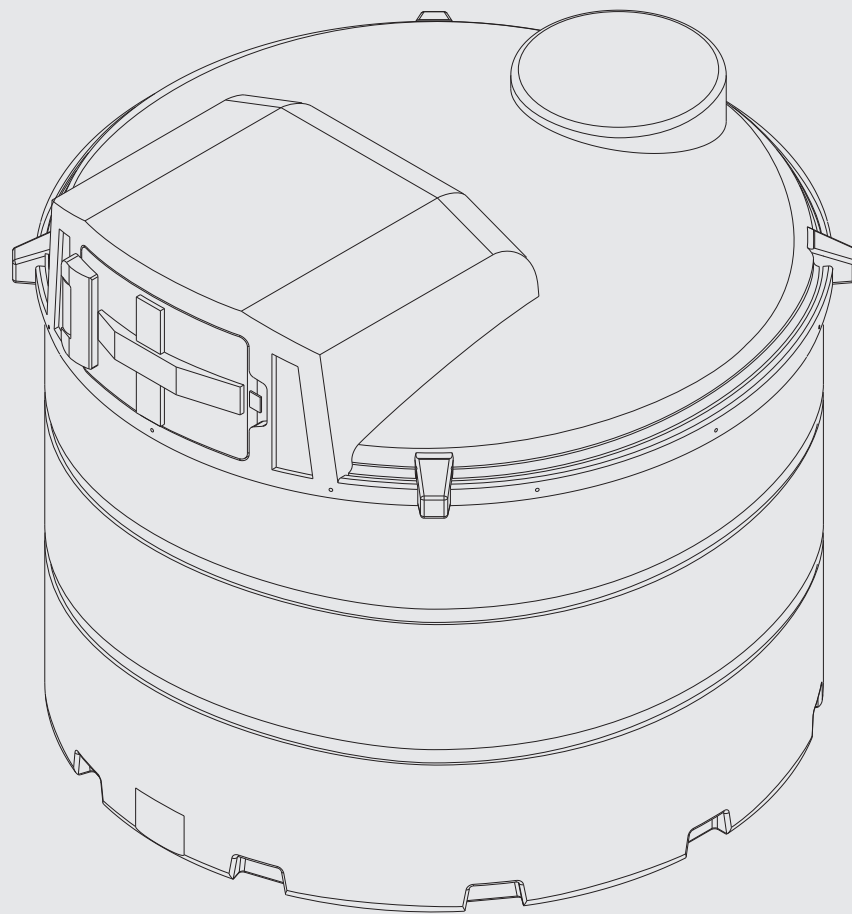

# V3500DD

Weight	-
Capacity	3500litres
Diameter	2060mm
Length	-
Width	2230mm
Height	1885mm
Ofcert licence No.	-

# V3500DD

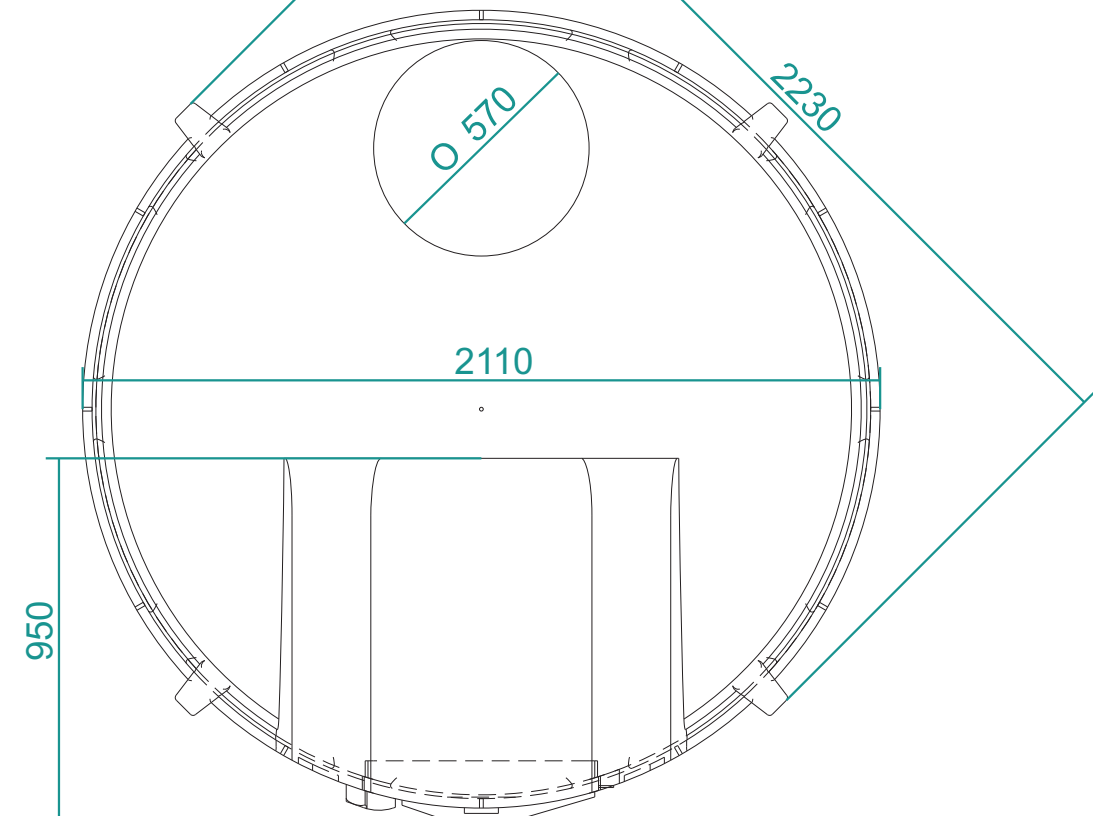
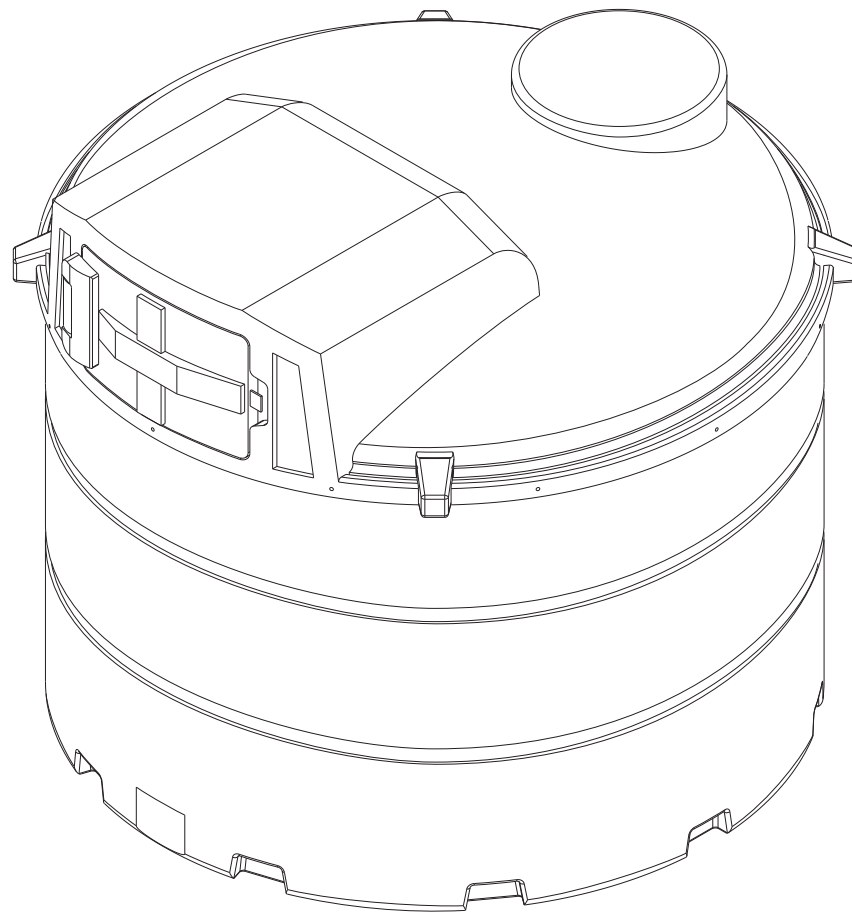
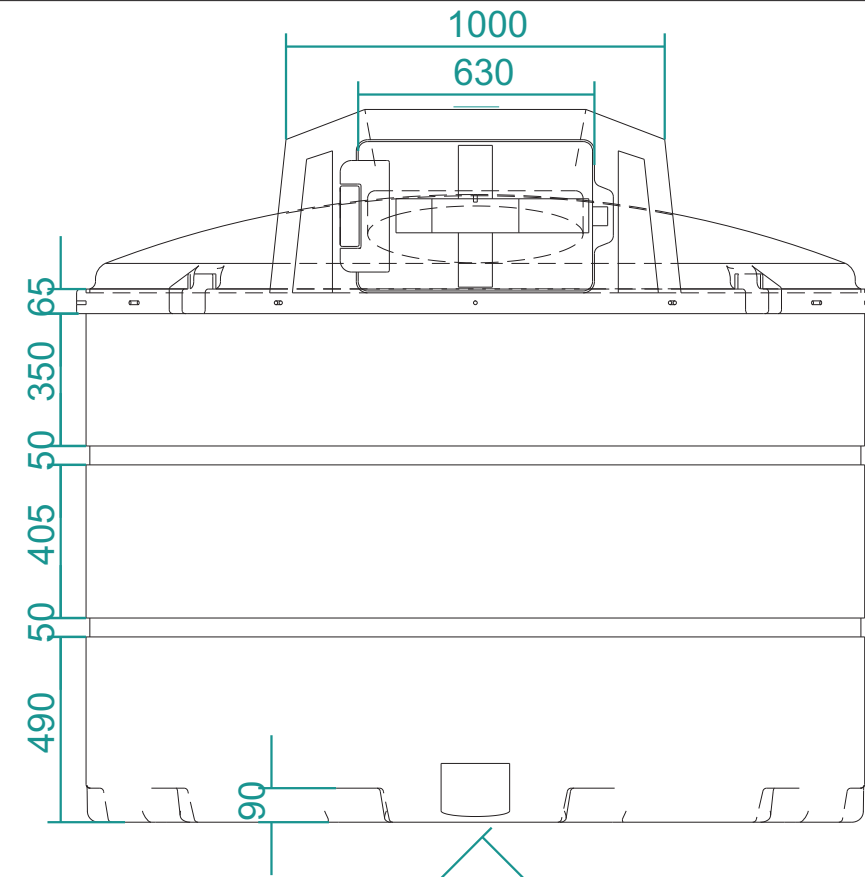
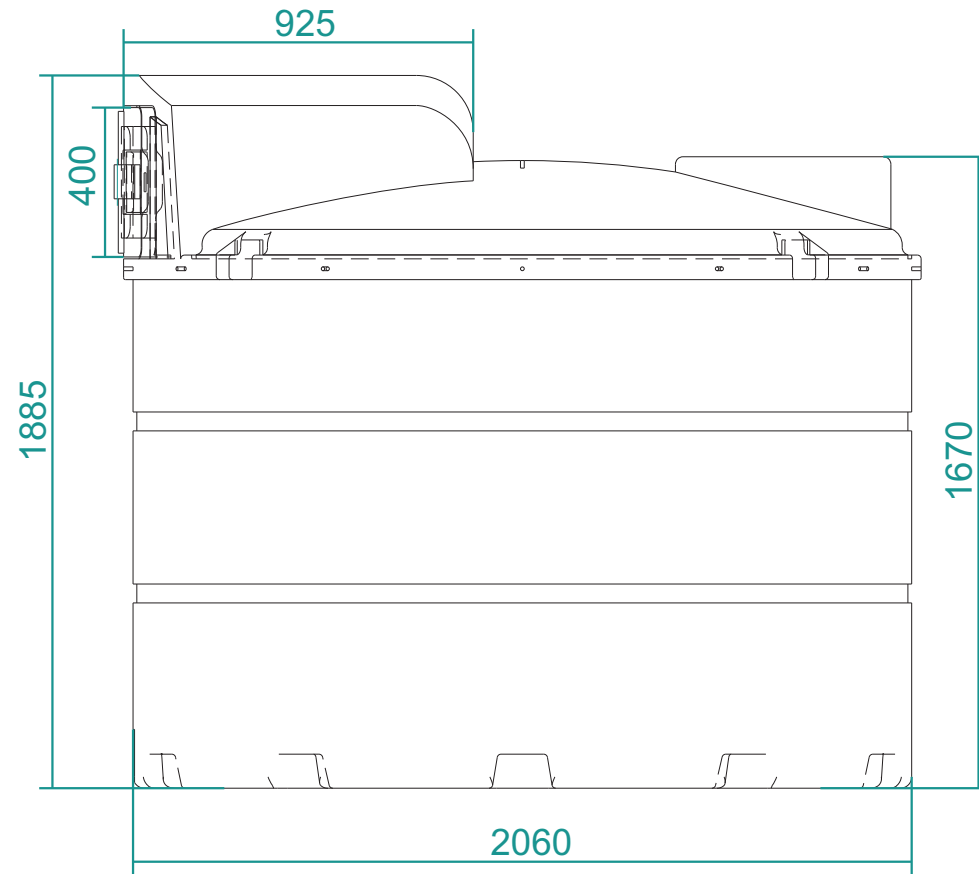

V3500DD	No. 1 of 1	3rd Angle Orthographic	scale: <b>1:20</b>	Design by Inky Design www.inky-design.co.uk
<b>DESO</b> ENGINEERING Telephone - 01984 632026		drawn by: Jonathan Taphouse (BEng)		
		date: 27 - 10 - 2010		ISO