



AUTHOR: JERRY SCANNELL

APPROVED BY: JS / SW

REV NO: R1.0

REV DATE: 21/09/2018

Tank Specification

Length: 1940 mm
Width: 840 mm
Height: 1390 mm

Product Mass: 136 kg

Capacity Brimful: 1174 litres
Capacity Nominal: 1111 litres

Material Tank: MDPE

Approval Number: 0654120501 (OFTEC)

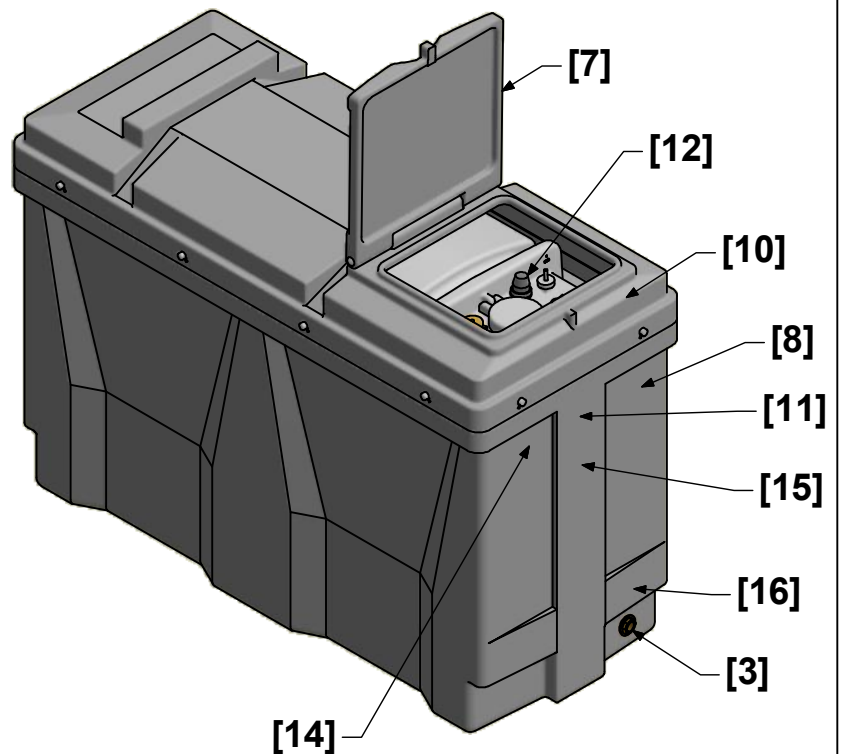

Equipment

1. 5" (~125mm) Inspection Lid - Lockable
2. 2" BSP (~50mm) Offset Fill Connection - Lockable
3. 1" BSP (~25mm) Bottom Outlet
4. Blanking Cap for Contents Gauge and Bund Alarm
5. 2" BSP (~50mm) Vent
6. Dip Stick
7. Spill Container Door - Lockable
8. Product Label
9. Tank Serial Number Stamp
10. Bund Serial Number Stamp
11. Installation Instruction
12. Overfill Prevention - Socket
13. Overfill Prevention - Probe
14. Carbery Graphic
15. CE Label
16. Left Hand Thread Label
17. Handle With Care Label

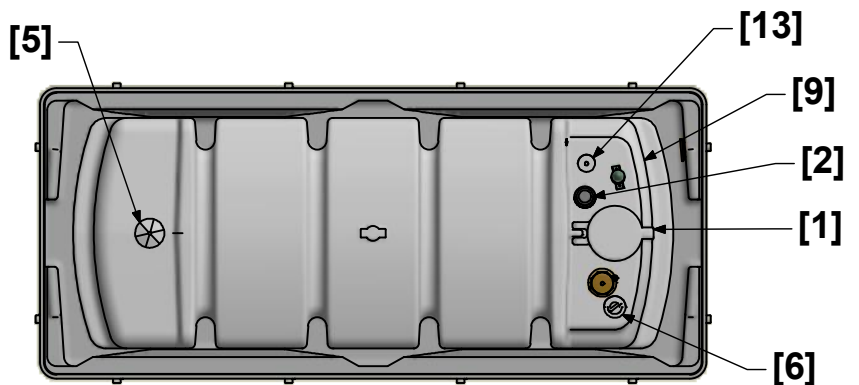

Options

18. BTGR01100R-105 [Apollo HG]

Installation & Siting Guidelines

Carbery Tanks must only be installed and commissioned by a suitably competent person in accordance with supplied instructions and all prevailing statutory requirements.

Please Consult the Installation, Operation and Maintenance Manual for further Information.

Certification

All Carbery Plastics LTD tanks are certified to EN13341.